

TYPE A

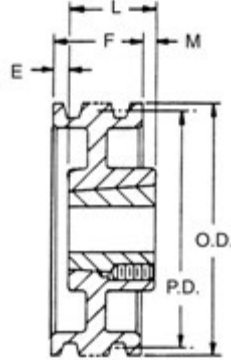

TYPE B

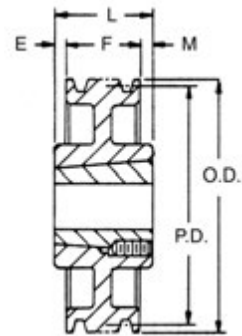

TYPE C



1 = SOLID



2 = WEB



3 = ARM/SPOKE

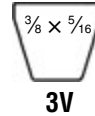

3V

Taper Bushed Sheaves — 3V

1 Groove										2 Groove							
F = 1/16"										F = 1/32"							
Part Number	Diameters		Type	Bush	Bush Max. Bore	E	L Thru Bore	M	Wt. Less Bush	Part Number	Type	Bush	Bush Max. Bore	E	L Thru Bore	M	Wt. Less Bush
	OD	Pitch 3V															
1 3V 265 TB	2.65	2.60	A-1	1108	1 1/8	7/32	7/8	0	.75	2 3V 265 TB	A-1	1108	1 1/8	7/32	7/8	0	.75
1 3V 280 TB	2.80	2.75	A-1	1108	1 1/8	7/32	7/8	0	.85	2 3V 280 TB	A-1	1108	1 1/8	7/32	7/8	0	.90
1 3V 300 TB	3.00	2.95	A-1	1108	1 1/8	7/32	7/8	0	1.00	2 3V 300 TB	A-1	1210	1 1/4	1/2	1	0	1.40
1 3V 315 TB	3.15	3.10	A-1	1108	1 1/8	7/32	7/8	0	1.25	2 3V 315 TB	A-1	1210	1 1/4	1/2	1	0	1.60
1 3V 335 TB	3.35	3.30	A-1	1610	1 5/8	0	1	0	1.50	2 3V 335 TB	A-1	1610	1 5/8	1/2	1	0	1.70
1 3V 365 TB	3.65	3.60	A-1	1610	1 5/8	0	1	0	2.00	2 3V 365 TB	A-1	1610	1 5/8	1/2	1 1/2	0	2.00
1 3V 412 TB	4.12	4.07	B-1	1610	1 5/8	0	1	13/32	2.25	2 3V 412 TB	A-1	1610	1 5/8	0	1	0	2.10
1 3V 450 TB	4.50	4.45	B-1	1610	1 5/8	0	1	13/32	3.00	2 3V 450 TB	A-1	1610	1 5/8	0	1	0	2.70
1 3V 475 TB	4.75	4.70	B-1	1610	1 5/8	0	1	13/32	3.25	2 3V 475 TB	A-1	1610	1 5/8	0	1	0	3.00
1 3V 500 TB	5.00	4.95	B-1	1610	1 5/8	0	1	13/32	3.50	2 3V 500 TB	A-1	1610	1 5/8	0	1	0	4.00
1 3V 530 TB	5.30	5.25	B-1	1610	1 5/8	0	1	13/32	3.75	2 3V 530 TB	A-1	1610	1 5/8	0	1	0	5.00
1 3V 560 TB	5.60	5.55	B-1	1610	1 5/8	0	1	13/32	4.00	2 3V 560 TB	A-1	1610	1 5/8	0	1	0	6.00
1 3V 600 TB	6.00	5.95	B-1	1610	1 5/8	0	1	13/32	5.00	2 3V 600 TB	A-1	1610	1 5/8	0	1	0	7.00
1 3V 650 TB	6.50	6.45	B-1	1610	1 5/8	0	1	13/32	6.00	2 3V 650 TB	A-1	1610	1 5/8	0	1	0	8.00
1 3V 690 TB	6.90	6.85	B-1	1610	1 5/8	0	1	13/32	7.00	2 3V 690 TB	A-1	1610	1 5/8	0	1	0	9.00
1 3V 800 TB	8.00	7.95	B-2	2517	2 1/2	0	1 3/4	1 1/16	9.00	2 3V 800 TB	B-2	2517	2 1/2	0	1 3/4	2 1/2	10.0
1 3V 1060 TB	10.60	10.55	B-2	2517	2 1/2	0	1 3/4	1 1/16	13.00	2 3V 1060 TB	B-2	2517	2 1/2	0	1 3/4	2 1/2	14.0
1 3V 1400 TB*	14.00	13.95	B-3	2517	2 1/2	0	1 3/4	1 5/16	15.00	2 3V 1400 TB	B-3	2517	2 1/2	0	1 3/4	2 1/2	18.0
1 3V 1900 TB*	19.00	18.95	B-3	3020	3	0	2	1 3/8	27.00	2 3V 1900 TB	B-3	3020	3	0	2	2 1/2	32.0
	25.00	24.95								2 3V 2500 TB	C-3	3020	3	1/8	2	2 1/2	45.0

* F = 1/16" thru 1 3V 1400 TB

F = 3/16" thru 1 3V 1400 TB and 1 3V 1900 TB

3V Hi-Cap Wedge Stock Taper Bushed Sheaves

Martin

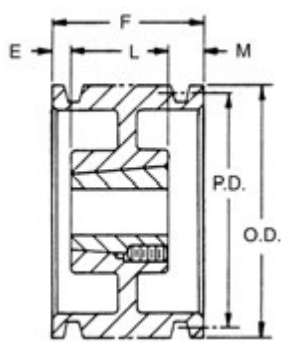

TYPE A

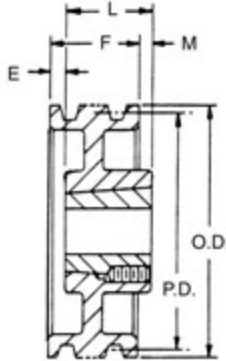

TYPE B

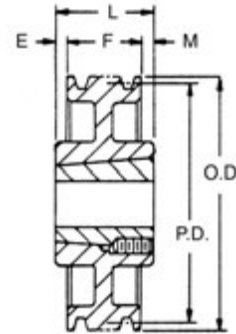

TYPE C



1 = SOLID



2 = WEB

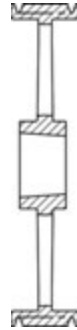

3 = ARM/SPOKE



3V

Taper Bushed Sheaves — 3V

3 Groove F = 1½										4 Groove F = 1 ²⁹ / ₃₂							
Part Number	Diameter		Type	Bush	Bush Max. Bore	E	L Thru Bore	M	Wt. Less Bush	Part Number	Type	Bush	Bush Max. Bore	E	L Thru Bore	M	Wt. Less Bush
	OD	Pitch 3V															
3 3V 265 TB	2.65	2.60	A-1	1108	1½	5/8	7/8	0	1.0	4 3V 265 TB	A-1	1108	1½	1½/2	7/8	0	1.2
3 3V 280 TB	2.80	2.75	A-1	1108	1½	5/8	7/8	0	1.1	4 3V 280 TB	A-1	1108	1½	1½/2	7/8	0	1.3
3 3V 300 TB	3.00	2.95	A-1	1210	1¼	29/32	1	0	1.8	4 3V 300 TB	A-1	1210	1¼	1½/16	1	0	2.1
3 3V 315 TB	3.15	3.10	A-1	1210	1¼	29/32	1	0	2.0	4 3V 315 TB	A-1	1210	1¼	1½/16	1	0	2.2
3 3V 335 TB	3.35	3.30	A-1	1610	1½	29/32	1	0	2.3	4 3V 335 TB	A-1	1610	1½	1½/16	1	0	2.4
3 3V 365 TB	3.65	3.60	A-1	1610	1½	29/32	1	0	2.6	4 3V 365 TB	A-1	1610	1½	29/32	1	0	2.8
3 3V 412 TB	4.12	4.07	A-1	1610	1½	½	1	0	3.0	4 3V 412 TB	A-1	1610	1½	29/32	1	0	3.0
3 3V 450 TB	4.50	4.45	A-1	1610	1½	½	1	0	3.2	4 3V 450 TB	A-1	1610	1½	29/32	1	0	4.0
3 3V 475 TB	4.75	4.70	A-1	1610	1½	½	1	0	4.0	4 3V 475 TB	A-1	1610	1½	29/32	1	0	5.0
3 3V 500 TB	5.00	4.95	A-1	1610	1½	½	1	0	4.5	4 3V 500 TB	A-1	1610	1½	29/32	1	0	5.5
3 3V 530 TB	5.30	5.25	A-1	1610	1½	½	1	0	5.0	4 3V 530 TB	A-1	1610	1½	29/32	1	0	6.0
3 3V 560 TB	5.60	5.55	A-1	1610	1½	½	1	0	6.0	4 3V 560 TB	A-1	1610	1½	29/32	1	0	7.0
3 3V 600 TB	6.00	5.95	B-1	2517	2½	5/32	1¾	13/32	7.0	4 3V 600 TB	A-1	2517	2½	5/32	1¾	0	8.0
3 3V 650 TB	6.50	6.45	B-1	2517	2½	5/32	1¾	13/32	9.0	4 3V 650 TB	A-1	2517	2½	5/32	1¾	0	10.0
3 3V 690 TB	6.90	6.85	B-1	2517	2½	5/32	1¾	13/32	10.0	4 3V 690 TB	A-1	2517	2½	5/32	1¾	0	12.0
3 3V 800 TB	8.00	7.95	B-1	2517	2½	5/32	1¾	13/32	15.0	4 3V 800 TB	A-1	2517	2½	5/32	1¾	0	18.0
3 3V 1060 TB	10.60	10.55	B-2	2517	2½	0	1¾	¼	18.0	4 3V 1060 TB	A-2	2517	2½	5/32	1¾	0	19.0
3 3V 1400 TB	14.00	13.95	B-3	2517	2½	0	1¾	¼	20.0	4 3V 1400 TB	A-3	2517	2½	0	1¾	5/32	22.0
3 3V 1900 TB	19.00	18.95	B-3	3020	3	0	2	½	36.0	4 3V 1900 TB	C-3	3020	3	0	2	3/32	45.0
3 3V 2500 TB	25.00	24.95	B-3	3020	3	0	2	½	47.0	4 3V 2500 TB	C-3	3020	3	0	2	3/32	63.0
3 3V 3350 TB	33.50	33.45	B-3	3020	3	¼	2	¼	76.0	4 3V 3350 TB	C-3	3030	3	35/64	3	35/64	80.0

Dimensions in inches, weight in pounds. Weights do not include bushings. See page B-8 thru B-10 for additional bushing dimensions.

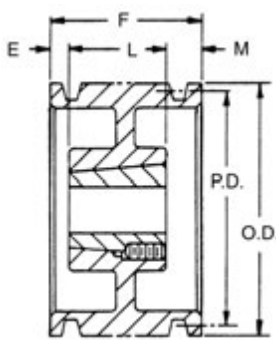

TYPE A

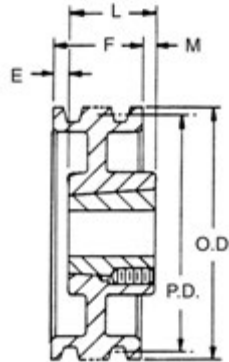

TYPE B

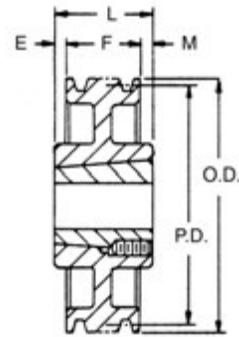

TYPE C

Taper Bushed Sheaves — 3V

5 Groove										6 Groove							
F = 2 ⁵ / ₁₆										F = 2 ²³ / ₃₂							
Part Number	Diameter		Type	Bush	Bush Max. Bore	E	L Thru Bore	M	Wt. Less Bush	Part Number	Type	Bush	Bush Max. Bore	E	L Thru Bore	M	Wt. Less Bush
	OD	Pitch 3V															
5 3V 450 TB	4.50	4.45	A-1	1615	1 ¹ / ₂	0	1 ¹ / ₂	¹ / ₁₆	4.0	6 3V 475 TB	A-1	2517	2 ¹ / ₂	³ / ₃₂	1 ¹ / ₄	0	4.4
5 3V 475 TB	4.75	4.70	A-1	2517	2 ¹ / ₂	¹ / ₁₆	1 ¹ / ₄	0	4.0	6 3V 500 TB	A-1	2517	2 ¹ / ₂	³ / ₃₂	1 ¹ / ₄	0	5.4
5 3V 500 TB	5.00	4.95	A-1	2517	2 ¹ / ₂	¹ / ₁₆	1 ¹ / ₄	0	4.8	6 3V 530 TB	A-1	2517	2 ¹ / ₂	³ / ₃₂	1 ¹ / ₄	0	6.5
5 3V 530 TB	5.30	5.25	A-1	2517	2 ¹ / ₂	¹ / ₁₆	1 ¹ / ₄	0	5.9	6 3V 560 TB	A-1	2517	2 ¹ / ₂	³ / ₃₂	1 ¹ / ₄	0	7.7
5 3V 560 TB	5.60	5.55	A-1	2517	2 ¹ / ₂	¹ / ₁₆	1 ¹ / ₄	0	7.0	6 3V 600 TB	A-1	2517	2 ¹ / ₂	³ / ₃₂	1 ¹ / ₄	0	9.5
5 3V 600 TB	6.00	5.95	A-1	2517	2 ¹ / ₂	¹ / ₁₆	1 ¹ / ₄	0	8.0	6 3V 650 TB	A-1	2517	2 ¹ / ₂	³ / ₃₂	1 ¹ / ₄	0	12.0
5 3V 650 TB	6.50	6.45	A-1	2517	2 ¹ / ₂	¹ / ₁₆	1 ¹ / ₄	0	11.0	6 3V 690 TB	A-1	2517	2 ¹ / ₂	³ / ₃₂	1 ¹ / ₄	0	13.0
5 3V 690 TB	6.90	6.85	A-1	2517	2 ¹ / ₂	¹ / ₁₆	1 ¹ / ₄	0	13.0	6 3V 800 TB	A-1	2517	2 ¹ / ₂	³ / ₃₂	1 ¹ / ₄	0	20.0
5 3V 800 TB	8.00	7.95	A-1	2517	2 ¹ / ₂	¹ / ₁₆	1 ¹ / ₄	0	19.0	6 3V 1060 TB	A-2	2517	2 ¹ / ₂	³ / ₃₂	1 ¹ / ₄	0	21.0
5 3V 1060 TB	10.60	10.55	A-2	2517	2 ¹ / ₂	¹ / ₁₆	1 ¹ / ₄	0	21.0	6 3V 1400 TB	A-3	2517	2 ¹ / ₂	⁷ / ₃₂	1 ¹ / ₄	0	30.0
5 3V 1400 TB	14.00	13.95	A-3	2517	2 ¹ / ₂	0	1 ¹ / ₄	¹ / ₁₆	30.0	6 3V 1900 TB	B-3	3020	3	0	2	²³ / ₃₂	51.0
5 3V 1900 TB	19.00	18.95	A-3	3030	3	0	2	⁵ / ₁₆	51.0	6 3V 2500 TB	B-3	3030	3	0	3	³ / ₂	81.0
5 3V 2500 TB	25.00	24.95	B-3	3030	3	0	3	¹ / ₁₆	76.0	6 3V 3350 TB	C-3	3030	3	⁹ / ₆₄	3	⁹ / ₆₄	110.0
5 3V 3350 TB	33.50	33.45	C-3	3030	3	¹ / ₃₂	3	¹ / ₃₂	97.0								

8 Groove										10 Groove							
F = 3 ¹⁷ / ₃₂										F = 4 ¹ / ₃₂							
Part Number	Diameter		Type	Bush	Bush Max. Bore	E	L Thru Bore	M	Wt. Less Bush	Part Number	Type	Bush	Bush Max. Bore	E	L Thru Bore	M	Wt. Less Bush
	OD	Pitch 3V															
8 3V 475 TB	4.75	4.70	A-1	2517	2 ¹ / ₂	1 ²⁵ / ₃₂	1 ¹ / ₄	0	5.0	10 3V 475 TB	A-1	2517	2 ¹ / ₂	2 ¹⁹ / ₃₂	1 ¹ / ₄	0	6.0
8 3V 500 TB	5.00	4.95	A-1	2517	2 ¹ / ₂	1 ²⁵ / ₃₂	1 ¹ / ₄	0	6.0	10 3V 500 TB	A-1	2517	2 ¹ / ₂	2 ¹⁹ / ₃₂	1 ¹ / ₄	0	7.0
8 3V 530 TB	5.30	5.25	A-1	2517	2 ¹ / ₂	1 ¹ / ₃₂	1 ¹ / ₄	³ / ₄	7.8	10 3V 530 TB	A-1	2517	2 ¹ / ₂	1 ²⁷ / ₃₂	1 ¹ / ₄	³ / ₄	8.0
8 3V 560 TB	5.60	5.55	A-1	2517	2 ¹ / ₂	¹ / ₄	1 ¹ / ₄	1 ¹⁷ / ₃₂	9.0	10 3V 560 TB	A-1	2517	2 ¹ / ₂	¹ / ₂	1 ¹ / ₄	2 ³ / ₃₂	9.0
8 3V 600 TB	6.00	5.95	A-1	2517	2 ¹ / ₂	¹ / ₄	1 ¹ / ₄	1 ¹⁷ / ₃₂	11.0	10 3V 600 TB	A-1	2517	2 ¹ / ₂	¹ / ₂	1 ¹ / ₄	2 ³ / ₃₂	12.0
8 3V 650 TB	6.50	6.45	A-1	2517	2 ¹ / ₂	¹ / ₄	1 ¹ / ₄	1 ¹⁷ / ₃₂	13.0	10 3V 650 TB	A-1	2517	2 ¹ / ₂	¹ / ₂	1 ¹ / ₄	2 ³ / ₃₂	14.0
8 3V 690 TB	6.90	6.85	A-1	2517	2 ¹ / ₂	¹ / ₄	1 ¹ / ₄	1 ¹⁷ / ₃₂	15.0	10 3V 690 TB	A-1	2517	2 ¹ / ₂	¹ / ₂	1 ¹ / ₄	2 ³ / ₃₂	17.0
8 3V 800 TB	8.00	7.95	A-1	3020	3	¹ / ₂	2	1 ¹ / ₃₂	19.0	10 3V 800 TB	A-1	3020	3	¹ / ₄	2	2 ³ / ₃₂	22.0
8 3V 1060 TB	10.60	10.55	A-2	3020	3	¹ / ₂	2	1 ¹ / ₃₂	26.0	10 3V 1060 TB	A-2	3020	3	²⁷ / ₃₂	2	1 ¹ / ₂	32.0
8 3V 1400 TB	14.00	13.95	A-3	3020	3	² / ₃₂	2	⁷ / ₁₆	52.0	10 3V 1400 TB	A-2	3535	3 ¹ / ₂	0	3 ¹ / ₂	²⁷ / ₃₂	59.0
8 3V 1900 TB	19.00	18.95	A-3	3535	3 ¹ / ₂	0	3 ¹ / ₂	¹ / ₃₂	63.0	10 3V 1900 TB	A-3	3535	3 ¹ / ₂	0	3 ¹ / ₂	²⁷ / ₃₂	71.0
8 3V 2500 TB	25.00	24.95	A-3	3535	3 ¹ / ₂	0	3 ¹ / ₂	¹ / ₃₂	89.0	10 3V 2500 TB	A-3	4040	4	0	4	¹ / ₃₂	121.0
8 3V 3350 TB	33.50	33.45	C-3	4040	4	¹⁵ / ₆₄	4	¹⁵ / ₆₄	131.0	10 3V 3350 TB	A-3	4040	4	¹ / ₆₄	4	¹ / ₃₂	172.0

5V Hi-Cap Wedge Stock Taper Bushed Sheaves

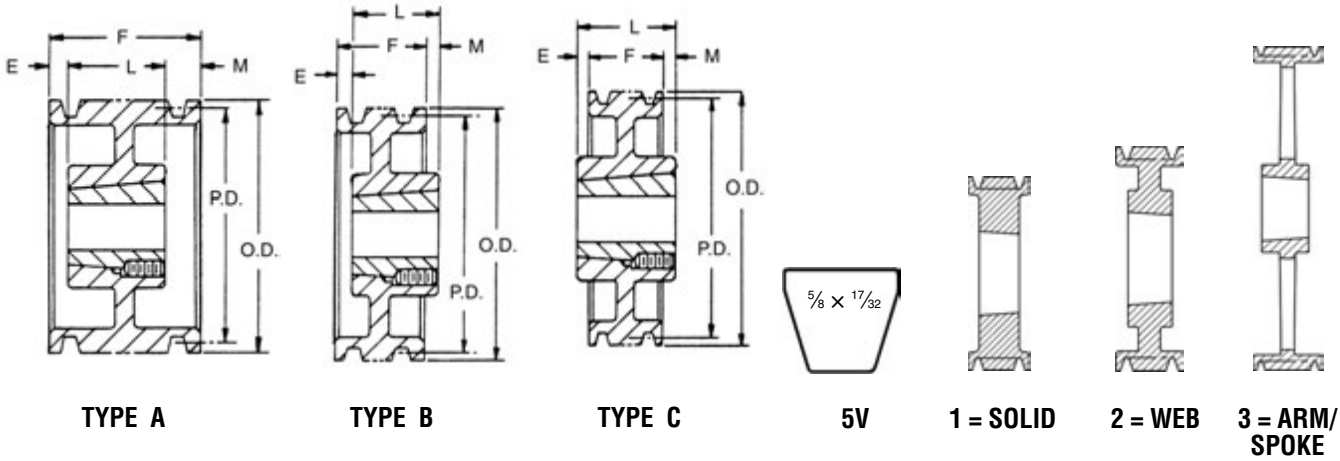

Taper Bushed Sheaves — 5V

2 Groove F = 1 1/16										3 Groove F = 2 3/8							
Part Number	Diameter		Type	Bush	Bush Max. Bore	E	L Thru Bore	M	Wt. Less Bush	Part Number	Type	Bush	Bush Max. Bore	E	L Thru Bore	M	Wt. Less Bush
	OD	Pitch 5V															
* 2 5V 440 TB	4.4	4.30	A-1	1610	1%	1/16	1	5/8	3.0	* 3 5V 440 TB	A-1	1610	1%	1%	1	0	4.0
* 2 5V 465 TB	4.65	4.55	A-1	1610	1%	1/16	1	5/8	3.0	* 3 5V 465 TB	A-1	1610	1%	1/16	1	1 1/16	5.0
* 2 5V 490 TB	4.9	4.80	A-1	1610	1%	1/16	1	5/8	4.0	* 3 5V 490 TB	A-1	1610	1%	1/16	1	1 1/16	5.0
* 2 5V 520 TB	5.2	5.10	A-1	1610	1%	1/16	1	5/8	4.2	* 3 5V 520 TB	A-1	1610	1%	1/16	1	1 1/16	6.0
* 2 5V 550 TB	5.5	5.40	A-1	1610	1%	1/16	1	5/8	5.2	* 3 5V 550 TB	A-1	1610	1%	1/16	1	1 1/16	6.0
* 2 5V 590 TB	5.9	5.8	A-1	1610	1%	1/16	1	5/8	5.6	* 3 5V 590 TB	A-1	2517	2 1/2	0	1 3/4	5/8	7.0
* 2 5V 630 TB	6.3	6.20	A-1	1610	1%	0	1	1 1/16	7.6	* 3 5V 630 TB	A-1	2517	2 1/2	0	1 3/4	5/8	9.0
* 2 5V 670 TB	6.7	6.60	A-1	1610	1%	0	1	1 1/16	9.4	* 3 5V 670 TB	A-1	2517	2 1/2	0	1 3/4	5/8	10.0
2 5V 710 TB	7.10	7.00	B-1	2517	2 1/2	1/16	1 3/4	0	10.0	3 5V 710 TB	A-1	2517	2 1/2	5/8	1 3/4	0	11.0
2 5V 750 TB	7.50	7.40	B-1	2517	2 1/2	1/16	1 3/4	0	13.0	3 5V 750 TB	A-1	2517	2 1/2	5/8	1 3/4	0	14.0
2 5V 800 TB	8.00	7.90	B-1	2517	2 1/2	1/16	1 3/4	0	14.0	3 5V 800 TB	A-1	2517	2 1/2	5/8	1 3/4	0	16.0
2 5V 850 TB	8.50	8.40	B-2	2517	2 1/2	1/16	1 3/4	0	15.0	3 5V 850 TB	A-2	2517	2 1/2	5/8	1 3/4	0	17.0
2 5V 900 TB	9.00	8.90	B-2	2517	2 1/2	1/16	1 3/4	0	16.0	3 5V 900 TB	A-2	2517	2 1/2	5/8	1 3/4	0	19.0
2 5V 925 TB	9.25	9.15	B-2	3020	3	0	2	5/16	17.0	3 5V 925 TB	A-1	3020	3	0	2	5/8	23.0
2 5V 975 TB	9.75	9.65	B-2	3020	3	0	2	5/16	18.0	3 5V 975 TB	A-1	3020	3	0	2	5/8	24.0
2 5V 1030 TB	10.30	10.20	B-2	3020	3	0	2	5/16	20.0	3 5V 1030 TB	A-2	3020	3	0	2	5/8	27.0
2 5V 1090 TB	10.90	10.80	B-2	3020	3	0	2	5/16	22.0	3 5V 1090 TB	A-2	3020	3	0	2	5/8	28.0
2 5V 1130 TB	11.30	11.20	B-2	3020	3	0	2	5/16	25.0	3 5V 1180 TB	A-2	3020	3	0	2	5/8	30.0
2 5V 1180 TB	11.80	11.70	B-2	3020	3	0	2	5/16	26.0	3 5V 1250 TB	A-2	3020	3	0	2	5/8	32.0
2 5V 1250 TB	12.50	12.40	B-2	3020	3	0	2	5/16	28.0	3 5V 1320 TB	A-2	3020	3	0	2	5/8	34.0
2 5V 1320 TB	13.20	13.10	B-3	3020	3	0	2	5/16	29.0	3 5V 1400 TB	A-3	3020	3	0	2	5/8	36.0
2 5V 1400 TB	14.00	13.90	B-3	3020	3	0	2	5/16	33.0	3 5V 1500 TB	A-3	3020	3	0	2	5/8	41.0
2 5V 1500 TB	15.00	14.90	B-3	3020	3	0	2	5/16	35.0	3 5V 1600 TB	A-3	3020	3	0	2	5/8	50.0
2 5V 1600 TB	16.00	15.90	B-3	3020	3	0	2	5/16	45.0	3 5V 1870 TB	A-3	3020	3	0	2	5/8	52.0
2 5V 1870 TB	18.7	18.60	C-3	3020	3	0	2	5/16	50.1	3 5V 2120 TB	B-3	3535	3 1/2	0	3 1/2	1 1/8	65.0
2 5V 2120 TB	21.20	21.10	C-3	3535	3 1/2	5/8	3 1/2	1 1/8	60.0	3 5V 2360 TB	C-3	3535	3 1/2	0	3 1/2	1 1/8	68.0
2 5V 2360 TB	23.6	23.50	C-3	3535	3 1/2	1/4	3 1/2	1 1/8	68.0	3 5V 2800 TB	B-3	3535	3 1/2	0	3 1/2	1 1/8	99.0
2 5V 2800 TB	28.00	27.90	C-3	3535	3 1/2	5/8	3 1/2	1 1/8	96.0	3 5V 3150 TB	C-3	3535	3 1/2	1 1/2	3 1/2	2 5/8	96.0
										3 5V 3750 TB	C-3	4040	4	1/2	4	1 1/8	172.0
										3 5V 5000 TB	C-3	4040	4	1/2	4	1 1/8	201.0

Dimensions in inches, weight in pounds. Weights do not include bushings. See page B-8 thru B-10 for additional bushing dimensions.

* 5VX Belts only on these sizes.

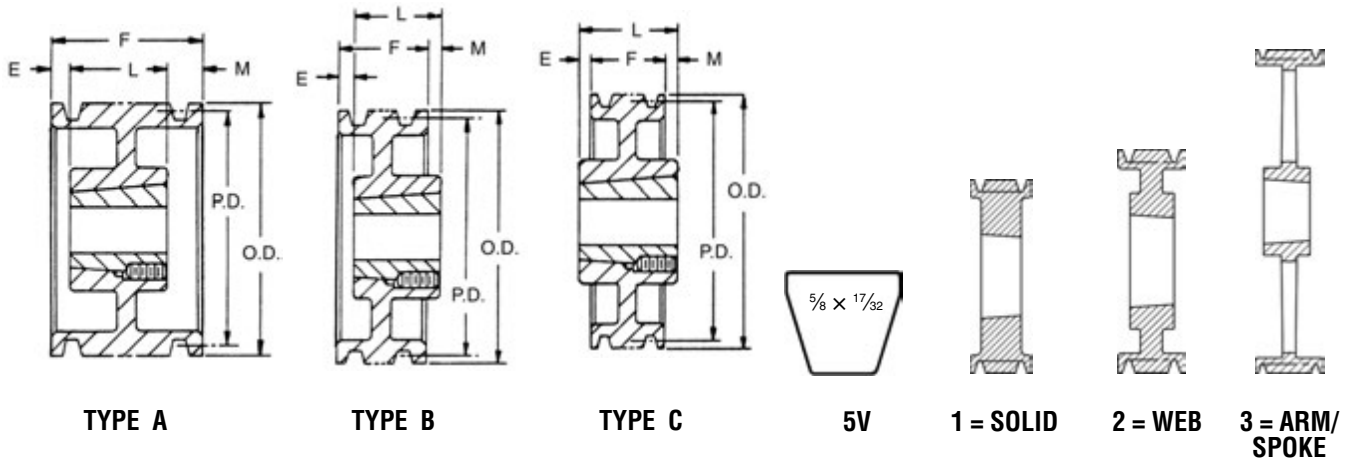

Taper Bushed Sheaves — 5V

4 Groove F = 3/16										5 Groove F = 3/4							
Part Number	Diameter		Type	Bush	Bush Max. Bore	E	L Thru Bore	M	Wt. Less Bush	Part Number	Type	Bush	Bush Max. Bore	E	L Thru Bore	M	Wt. Less Bush
	OD	Pitch 5V															
* 4 5V 440 TB	4.4	4.30	A-1	1610	1%	2 1/16	1	0	6.0								
* 4 5V 465 TB	4.65	4.55	A-1	1610	1%	2 1/16	1	0	6.0								
* 4 5V 490 TB	4.9	4.80	A-1	1610	1%	2 1/16	1	0	6.0								
* 4 5V 520 TB	5.2	5.10	A-1	1610	1%	2 1/16	1	0	7.0								
* 4 5V 550 TB	5.5	5.40	A-1	2517	2%	1 5/16	1 1/4	0	8.0								
* 4 5V 590 TB	5.9	5.80	A-1	2517	2%	1 5/16	1 1/4	0	10.0	* 5 5V 590 TB	A-1	2517	2 1/2	3/16	1 1/4	1 1/16	11.0
* 4 5V 630 TB	6.3	6.20	A-1	2517	2 1/2	0	1 1/4	1 1/16	11.0	* 5 5V 630 TB	A-1	2517	2 1/2	3/16	1 1/4	1 1/16	12.0
* 4 5V 670 TB	6.7	6.60	A-1	2517	2 1/2	0	1 1/4	1 1/16	12.0	* 5 5V 670 TB	A-1	2517	2 1/2	3/16	1 1/4	1 1/16	13.0
4 5V 710 TB	7.10	7.00	A-1	2517	2 1/2	1 1/16	1 1/4	0	14.0	5 5V 710 TB	A-1	3020	3	1/2	2	1 1/4	15.0
4 5V 750 TB	7.50	7.40	A-1	2517	2 1/2	1 1/16	1 1/4	0	16.0	5 5V 750 TB	A-1	3020	3	1/2	2	1 1/4	17.0
4 5V 800 TB	8.00	7.90	A-1	2517	2 1/2	1 1/16	1 1/4	0	17.0	5 5V 800 TB	A-1	3020	3	1/2	2	1 1/4	20.0
4 5V 850 TB	8.50	8.40	A-2	2517	2 1/2	1 1/16	1 1/4	0	18.0	5 5V 850 TB	A-1	3020	3	1/2	2	1 1/4	22.0
4 5V 900 TB	9.00	8.90	A-2	2517	2 1/2	1 1/16	1 1/4	0	19.0	5 5V 900 TB	A-1	3020	3	1/2	2	1 1/4	30.0
4 5V 925 TB	9.25	9.15	A-1	3020	3	1/2	2	3/16	22.0	5 5V 925 TB	A-1	3020	3	1/2	2	1 1/4	36.0
4 5V 975 TB	9.75	9.65	A-1	3020	3	1/2	2	3/16	27.0	5 5V 975 TB	A-1	3020	3	1/2	2	1 1/4	37.0
4 5V 1030 TB	10.30	10.20	A-2	3020	3	1/2	2	3/16	28.0	5 5V 1030 TB	A-2	3020	3	1/2	2	1 1/4	38.0
4 5V 1090 TB	10.90	10.80	A-2	3020	3	1/2	2	3/16	31.0	5 5V 1090 TB	A-2	3020	3	1/2	2	1 1/4	39.0
4 5V 1130 TB	11.3	11.20	A-1	3020	3	0	2	1 1/16	32.0	5 5V 1130 TB	A-1	3020	3	1/2	2	1 1/4	38.0
4 5V 1180 TB	11.80	11.70	A-2	3020	3	1/2	2	3/16	35.0	5 5V 1180 TB	A-2	3020	3	1/2	2	1 1/4	40.0
4 5V 1250 TB	12.50	12.40	A-2	3020	3	0	2	1 1/16	44.0	5 5V 1250 TB	A-2	3535	3 1/2	0	3 1/2	1/4	50.0
4 5V 1320 TB	13.20	13.10	A-3	3020	3	0	2	1 1/16	42.0	5 5V 1320 TB	A-2	3535	3 1/2	0	3 1/2	1/4	56.0
4 5V 1400 TB	14.00	13.90	B-3	3535	3 1/2	0	3 1/2	3/16	53.0	5 5V 1400 TB	A-3	3535	3 1/2	0	3 1/2	1/4	58.0
4 5V 1500 TB	15.00	14.90	B-3	3535	3 1/2	0	3 1/2	3/16	54.0	5 5V 1500 TB	A-3	3535	3 1/2	0	3 1/2	1/4	65.0
4 5V 1600 TB	16.00	15.90	B-3	3535	3 1/2	0	3 1/2	3/16	60.0	5 5V 1600 TB	A-3	3535	3 1/2	0	3 1/2	1/4	70.0
4 5V 1870 TB	18.7	18.60	C-3	3535	3 1/2	3/16	3 1/2	0	63.0	5 5V 1870 TB	A-3	3535	3 1/2	0	3 1/2	1/4	84.0
4 5V 2120 TB	21.20	21.10	B-3	3535	3 1/2	0	3 1/2	3/16	72.0	5 5V 2120 TB	B-3	4040	4	0	4	1/4	115.0
4 5V 2360 TB	23.6	23.50	C-3	3535	3 1/2	0	3 1/2	3/16	79.0	5 5V 2360 TB	C-3	4040	4	0	4	1/4	92.0
4 5V 2800 TB	28.00	27.90	B-3	3535	3 1/2	0	3 1/2	3/16	125.0	5 5V 2800 TB	B-3	4040	4	0	4	1/4	160.0
4 5V 3150 TB	31.5	31.40	C-3	3535	3 1/2	0	3 1/2	3/16	114.0	5 5V 3150 TB	A-3	4040	4	0	4	1/4	155.0
4 5V 3750 TB	37.50	37.40	B-3	4040	4	0	4	1 1/16	189.0	5 5V 3750 TB	B-3	4040	4	0	4	1/4	182.0
4 5V 5000 TB	50.00	49.90	B-3	4040	4	0	4	1 1/16	371.0	5 5V 5000 TB	B-3	4545	4 1/2	0	4 1/2	3/4	288.0

Dimensions in inches, weight in pounds. Weights do not include bushings. See page B-8 thru B-10 for additional bushing dimensions.

* 5VX Belts only on these sizes.

5V Hi-Cap Wedge Stock Taper Bushed Sheaves

Taper Bushed Sheaves — 5V

6 Groove										8 Groove							
F = 4 ⁷ / ₁₆										F = 5 ¹³ / ₁₆							
Part Number	Diameter		Type	Bush	Bush Max. Bore	E	L Thru Bore	M	Wt. Less Bush	Part Number	Type	Bush	Bush Max. Bore	E	L Thru Bore	M	Wt. Less Bush
	OD	Pitch 5V															
* 6 5V 590 TB	5.90	5.80	A-1	2517	2½	1½	1¾	1⅞	13.0								
* 6 5V 630 TB	6.30	6.20	A-1	2517	2½	1⅜	1¾	1⅞	13.0								
* 6 5V 670 TB	6.70	6.60	A-1	2517	2½	1⅜	1¾	1⅞	15.0								
6 5V 710 TB	7.10	7.00	A-1	3020	3	¾	2	1⅞	17.0	8 5V 710 TB	A-1	3030	3	1	3	1⅜	24.0
6 5V 750 TB	7.50	7.40	A-1	3020	3	¾	2	1⅞	20.0	8 5V 750 TB	A-1	3030	3	1	3	1⅜	27.0
6 5V 800 TB	8.00	7.90	A-1	3020	3	¾	2	1⅞	24.0	8 5V 800 TB	A-1	3030	3	1	3	1⅜	33.0
6 5V 850 TB	8.50	8.40	A-1	3020	3	¾	2	1⅞	28.0	8 5V 850 TB	A-1	3030	3	1	3	1⅜	39.0
6 5V 900 TB	9.00	8.90	A-1	3020	3	¾	2	1⅞	32.0	8 5V 900 TB	A-1	3535	3½	1	3½	1⅞	44.0
6 5V 925 TB	9.25	9.15	A-1	3535	3½	0	3	1⅞	39.0	8 5V 925 TB	A-1	3535	3½	1	3½	1⅞	48.0
6 5V 975 TB	9.75	9.65	A-1	3535	3½	0	3½	1⅞	50.0	8 5V 975 TB	A-1	3535	3½	1	3½	1⅞	55.0
6 5V 1030 TB	10.30	10.20	A-1	3535	3½	0	3½	1⅞	58.0	8 5V 1030 TB	A-1	3535	3½	1	3½	1⅞	64.0
6 5V 1090 TB	10.90	10.80	A-1	3535	3½	0	3½	1⅞	60.0	8 5V 1090 TB	A-1	3535	3½	1	3½	1⅞	68.0
	11.30	11.20								8 5V 1130 TB	A-1	3535	3½	1	3½	1⅞	57.0
6 5V 1180 TB	11.80	11.70	A-2	3535	3½	0	3½	1⅞	62.0	8 5V 1180 TB	A-1	3535	3½	1	3½	1⅞	74.0
6 5V 1250 TB	12.50	12.40	A-2	3535	3½	0	3½	1⅞	65.0	8 5V 1250 TB	A-1	4040	4	¼	4	1⅞	82.0
6 5V 1320 TB	13.20	13.10	A-2	3535	3½	0	3½	1⅞	68.0	8 5V 1320 TB	A-1	4040	4	¼	4	1⅞	87.0
6 5V 1400 TB	14.00	13.90	A-2	3535	3½	0	3½	1⅞	72.0	8 5V 1400 TB	A-2	4040	4	¼	4	1⅞	90.0
6 5V 1500 TB	15.00	14.90	A-2	4040	4	0	4	¾	91.0	8 5V 1500 TB	A-2	4040	4	¼	4	1⅞	97.0
6 5V 1600 TB	16.00	15.90	A-3	4040	4	0	4	¾	97.0	8 5V 1600 TB	A-3	4040	4	¼	4	1⅞	106.0
6 5V 1870 TB	18.70	18.60	A-2	4040	4	0	4	¾	97.0	8 5V 1870 TB	A-3	4040	4	¼	4	1⅞	112.0
6 5V 2120 TB	21.20	21.10	A-3	4040	4	0	4	¾	123.0	8 5V 2120 TB	A-3	4040	4	¼	4	1⅞	144.0
6 5V 2360 TB	23.60	23.50	A-3	4040	4	0	4	¾	124.0	8 5V 2360 TB	A-3	4040	4	¼	4	1⅞	145.0
6 5V 2800 TB	28.00	27.90	A-3	4040	4	0	4	¾	176.0	8 5V 2800 TB	A-3	4545	4½	¼	4½	1⅞	206.0
6 5V 3150 TB	31.50	31.40	A-3	4040	4	0	4	¾	171.0	8 5V 3150 TB	A-3	4545	4½	¼	4½	1⅞	228.0
6 5V 3750 TB	37.50	37.40	B-3	4545	4½	0	4½	¾	254.0	8 5V 3750 TB	A-3	4545	4½	¼	4½	1⅞	271.0
6 5V 5000 TB	50.00	49.90	B-3	4545	4½	0	4½	¾	386.0	8 5V 5000 TB	A-3	4545	4½	¼	4½	1⅞	458.0

Taper Bushed Sheaves — 5V

10 Groove									
F = 7 ³ / ₁₆									
Part Number	Diameter		Type	Bush	Bush Max. Bore	E	L Thru Bore	M	Wt. Less Bush
	OD	Pitch 5V							
10 5V 800 TB	8.00	7.90	A-1	3030	3	1	3	3⅞	36.0
10 5V 850 TB	8.50	8.40	A-1	3030	3	1	3	3⅞	42.0
10 5V 900 TB	9.00	8.90	A-1	3535	3½	1	3½	2⅞	47.0
10 5V 925 TB	9.25	9.15	A-1	4040	4	1	4	2⅞	50.0
10 5V 975 TB	9.75	9.65	A-1	4040	4	1	4	2⅞	58.0
10 5V 1030 TB	10.30	10.20	A-1	4040	4	1	4	2⅞	69.0
10 5V 1090 TB	10.90	10.80	A-1	4040	4	1	4	2⅞	79.0
10 5V 1130 TB	11.30	11.20	A-1	4040	4	1	4	2⅞	80.0
10 5V 1180 TB	11.80	11.70	A-1	4040	4	1	4	2⅞	96.0
10 5V 1250 TB	12.50	12.40	A-2	4040	4	¾	4	2⅞	116.0
10 5V 1320 TB	13.20	13.10	A-2	4040	4	¾	4	2⅞	130.0
10 5V 1400 TB	14.00	13.90	A-2	4545	4½	¾	4½	1⅞	150.0
10 5V 1500 TB	15.00	14.90	A-2	4545	4½	¾	4½	1⅞	155.0
10 5V 1600 TB	16.00	15.90	A-2	4545	4½	¾	4½	1⅞	160.0
10 5V 1870 TB	18.70	18.60	A-2	4545	4½	½	4½	2⅞	116.0
10 5V 2120 TB	21.20	21.10	A-3	4545	4½	¾	4½	1⅞	210.0
10 5V 2360 TB	23.60	23.50	A-2	4545	4½	½	4½	2⅞	191.0
10 5V 2800 TB	28.00	27.90	A-3	4545	4½	¾	4½	1⅞	248.0
10 5V 3150 TB	31.50	31.40	A-3	4545	4½	¾	4½	1⅞	259.0
10 5V 3750 TB	37.50	37.40	A-3	4545	4½	¾	4½	1⅞	375.0
10 5V 5000 TB	50.00	49.90	A-3	5050	5	¾	5	1⅞	502.0

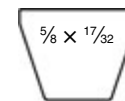

5V

Dimensions in inches, weight in pounds. Weights do not include bushings. See page B-8 thru B-10 for additional bushing dimensions.

* 5VX Belts only on these sizes.

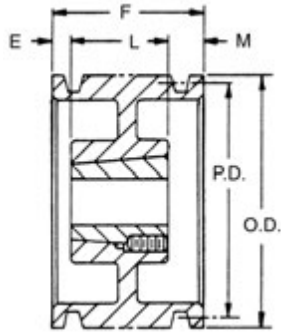

TYPE A

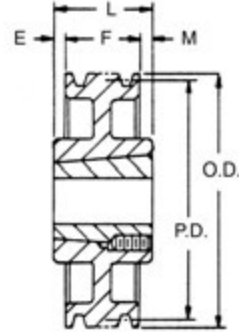

TYPE C



1 = SOLID



2 = WEB

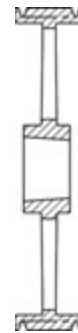

3 = ARM/SPOKE

Taper Bushed Sheaves — 8V

4 Groove										5 Groove							
F = 4 7/8										F = 6							
Part Number	Diameters		Type	Bush	Bush Max. Bore	E	L Thru Bore	M	Wt. Less Bush	Part Number	Type	Bush	Bush Max. Bore	E	L Thru Bore	M	Wt. Less Bush
	OD	Pitch 8V															
4 8V 1250 TB	12.5	12.3	A-1	4040	4	0	4	7/8	88.0	5 8V 1250 TB	A-1	4040	4	3/16	4	1 13/16	100.0
4 8V 1320 TB	13.2	13.0	A-1	4040	4	0	4	7/8	102.0	5 8V 1320 TB	A-1	4040	4	3/16	4	1 13/16	115.0
4 8V 1400 TB	14.0	13.8	A-1	4040	4	0	4	7/8	123.0	5 8V 1400 TB	A-1	4040	4	3/16	4	1 13/16	133.0
4 8V 1500 TB	15.0	14.8	A-1	4040	4	0	4	7/8	145.0	5 8V 1500 TB	A-1	4040	4	3/16	4	1 13/16	156.0
4 8V 1600 TB	16.0	15.8	A-2	4040	4	0	4	7/8	111.0	5 8V 1600 TB	A-1	4040	4	1/2	4	1 1/2	181.0
4 8V 1700 TB	17.0	16.8	A-2	4040	4	0	4	7/8	120.0	5 8V 1700 TB	A-2	4545	4 1/2	0	4 1/2	1 1/2	146.0
4 8V 1800 TB	18.0	17.8	A-2	4040	4	0	4	7/8	130.0	5 8V 1800 TB	A-2	4545	4 1/2	0	4 1/2	1 1/2	156.0
4 8V 1900 TB	19.0	18.8	A-2	4040	4	0	4	7/8	140.0	5 8V 1900 TB	A-2	4545	4 1/2	0	4 1/2	1 1/2	176.0
4 8V 2000 TB	20.0	19.8	A-2	4545	4 1/2	0	4 1/2	3/4	151.0	5 8V 2000 TB	A-2	4545	4 1/2	0	4 1/2	1 1/2	186.0
4 8V 2120 TB	21.2	21.0	A-3	4545	4 1/2	0	4 1/2	3/4	154.0	5 8V 2120 TB	A-3	4545	4 1/2	0	4 1/2	1 1/2	195.0
4 8V 2240 TB	22.4	22.2	A-3	4545	4 1/2	0	4 1/2	3/4	185.0	5 8V 2240 TB	A-3	4545	4 1/2	0	4 1/2	1 1/2	200.0
4 8V 2480 TB	24.8	24.6	D-3	5050	5	1/16	5	1 1/16	191.0	5 8V 2480 TB	A-3	5050	5	0	5	1 1/2	206.0
4 8V 3000 TB	30.0	29.8	C-3	5050	5	0	5	1/2	246.0	5 8V 3000 TB	A-3	5050	5	0	5	1	278.0
4 8V 3550 TB	35.5	35.3	D-3	5050	5	1 1/8	5	1	278.0	5 8V 3550 TB	A-3	5050	5	0	5	1	399.0
4 8V 4000 TB	40.0	39.8	B-3	5050	5	0	5	1/2	292.0	5 8V 4000 TB	A-3	5050	5	0	5	1	350.0
4 8V 4450 TB	44.5	44.3	D-3	5050	5	1/4	5	1/2	367.0	5 8V 4450 TB	A-3	5050	5	0	5	1	572.0
4 8V 5300 TB	53.0	52.8	B-3	5050	5	0	5	1/2	573.0	5 8V 5300 TB	A-3	5050	5	0	5	1	565.0

Dimensions in inches, weight in pounds. Weights do not include bushings. See page B-8 thru B-10 for additional bushing dimensions.

8V Hi-Cap Wedge Stock Taper Bushed Sheaves

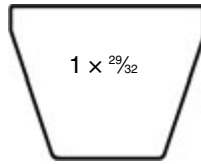

8V

Taper Bushed Sheaves — 8V

6 Groove F = 6%										8 Groove F = 9%							
Part Number	Diameters		Type	Bush	Bush Max. Bore	E	L Thru Bore	M	Wt. Less Bush	Part Number	Type	Bush	Bush Max. Bore	E	L Thru Bore	M	Wt. Less Bush
	OD	Pitch 8V															
6 8V 1250 TB	12.5	12.3	A-1	4040	4	1	4	2%	100.0	8 8V 1250 TB	A-1	4545	4%	1 1/2	4 1/2	3%	125.0
6 8V 1320 TB	13.2	13.0	A-1	4040	4	1	4	2%	124.0	8 8V 1320 TB	A-1	4545	4%	1 1/2	4 1/2	3%	135.0
6 8V 1400 TB	14.0	13.8	A-1	4040	4	1	4	2%	142.0	8 8V 1400 TB	A-1	4545	4%	1 1/2	4 1/2	3%	156.0
6 8V 1500 TB	15.0	14.8	A-1	4545	4 1/2	1/2	4 1/2	2%	153.0	8 8V 1500 TB	A-1	4545	4%	1 1/2	4 1/2	3%	160.0
6 8V 1600 TB	16.0	15.8	A-2	4545	4 1/2	1/2	4 1/2	2%	170.0	8 8V 1600 TB	A-2	4545	4%	1 1/2	4 1/2	3%	166.0
6 8V 1700 TB	17.0	16.8	A-2	4545	4 1/2	1/2	4 1/2	2%	175.0	8 8V 1700 TB	A-2	5050	5	1	5	3%	265.0
6 8V 1800 TB	18.0	17.8	A-2	4545	4 1/2	1/2	4 1/2	2%	180.0	8 8V 1800 TB	A-2	5050	5	1	5	3%	204.0
6 8V 1900 TB	19.0	18.8	A-2	4545	4 1/2	1/2	4 1/2	2%	182.0	8 8V 1900 TB	A-2	5050	5	1	5	3%	228.0
6 8V 2000 TB	20.0	19.8	A-2	5050	5	1/2	5	1%	226.0	8 8V 2000 TB	A-2	5050	5	1	5	3%	234.0
6 8V 2120 TB	21.2	21.0	A-3	5050	5	1/2	5	1%	246.0	8 8V 2120 TB	A-3	5050	5	1	5	3%	246.0
6 8V 2240 TB	22.4	22.2	A-3	5050	5	1/2	5	1%	267.0	8 8V 2240 TB	A-3	5050	5	1	5	3%	300.0
6 8V 2480 TB	24.8	24.6	D-3	5050	5	1/8	5	2 1/4	236.0	8 8V 2480 TB	A-3	5050	5	2%	5	2 1/4	285.0
6 8V 3000 TB	30.0	29.8	A-3	5050	5	1/2	5	1%	398.0	8 8V 3000 TB	A-3	5050	5	1	5	3%	384.0
6 8V 3550 TB	35.5	35.3	A-3	5050	5	1/2	5	1%	363.0	8 8V 3550 TB	A-3	5050	5	1	5	3%	441.0
6 8V 4000 TB	40.0	39.8	A-3	5050	5	1/2	5	1%	468.0	8 8V 4000 TB	A-3	5050	5	1	5	3%	556.0
6 8V 4450 TB	44.5	44.3	A-3	5050	5	1/2	5	1%	485.0	8 8V 4450 TB	A-3	6050	5	1	5	3%	596.0
6 8V 5300 TB	53.0	52.8	A-3	5050	5	1/2	5	1%	658.0	8 8V 5300 TB	A-3	6050	6	1	5	3%	1040.0

10 Groove F = 11%										12 Groove F = 13%							
Part Number	Diameters		Type	Bush	Bush Max. Bore	E	L Thru Bore	M	Wt. Less Bush	Part Number	Type	Bush	Bush Max. Bore	E	L Thru Bore	M	Wt. Less Bush
	OD	Pitch 8V															
10 8V 1320 TB	12.5	12.3	A-1	4545	4 1/2	1	4 1/2	6%	150.0	12 8V 1250 TB	A-1	5050	5	3 1/16	5	5 1/16	153.0
10 8V 1400 TB	14.0	13.8	A-1	4545	4 1/2	1	4 1/2	6%	180.0	12 8V 1320 TB	A-1	5050	5	3	5	5%	180.0
10 8V 1500 TB	15.0	14.8	A-1	5050	5	1	5	5%	211.0	12 8V 1400 TB	A-1	5050	5	3 1/16	5	5 1/16	186.0
10 8V 1600 TB	16.0	15.8	A-1	5050	5	1	5	5%	220.0	12 8V 1500 TB	A-2	5050	5	1%	5	7	221.0
10 8V 1700 TB	17.0	16.8	A-2	5050	5	2 1/4	5	4%	228.0	12 8V 1600 TB	A-2	5050	5	1%	5	7	247.0
10 8V 1800 TB	18.0	17.8	A-2	5050	5	2 1/4	5	4%	244.0	12 8V 1700 TB	A-2	5050	5	3 1/2	5	5%	267.0
10 8V 1900 TB	19.0	18.8	A-2	5050	5	2 1/4	5	4%	260.0	12 8V 1800 TB	A-2	5050	5	3 1/2	5	5 1/2	274.0
10 8V 2000 TB	20.0	19.8	A-2	5050	5	2 1/4	5	4%	270.0	12 8V 1900 TB	A-2	5050	5	2 1/4	5	6%	306.0
10 8V 2120 TB	21.2	21.0	A-2	5050	5	2 1/4	5	4%	282.0	12 8V 2000 TB	A-3	5050	5	2 1/4	5	6%	249.0
10 8V 2240 TB	22.4	22.2	A-3	5050	5	2 1/4	5	4%	312.0	12 8V 2120 TB	A-3	5050	5	2 1/4	5	6%	294.0
10 8V 2480 TB	24.8	24.6	A-3	5050	5	2%	5	4%	328.0	12 8V 2240 TB	A-3	5050	5	2 1/4	5	6%	337.0
10 8V 3000 TB	30.0	29.8	A-3	5050	5	2 1/4	5	4%	448.0	12 8V 2480 TB	A-3	5050	5	5%	5	3 1/2	380.0
10 8V 3550 TB	35.5	35.3	A-3	6050	6	2 1/4	5	4%	517.0	12 8V 3000 TB	A-3	6050	6	4	5	4%	482.0
10 8V 4000 TB	40.0	39.8	A-3	6050	6	2 1/4	5	4%	550.0	12 8V 3550 TB	A-3	6050	6	4	5	4%	597.0
10 8V 4450 TB	44.5	44.3	A-3	6050	6	2 1/4	5	4%	701.0	12 8V 4000 TB	A-3	6050	6	4	5	4%	702.0
10 8V 5300 TB	53.0	52.8	A-3	6050	6	2 1/4	5	4%	870.0	12 8V 4450 TB	A-3	6050	6	4	5	4%	814.0
										12 8V 5300 TB	A-3	7060	6	5	5	2%	1077.0

Dimensions in inches, weight in pounds. Weights do not include bushings. See page B-8 thru B-10 for additional bushing dimensions.

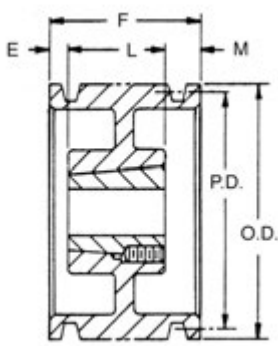

TYPE A

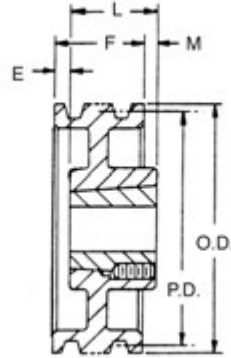

TYPE B

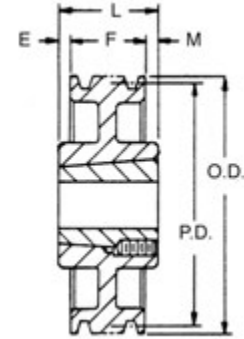

TYPE C

Taper Bushed Sheaves — A-B

1 Groove F = 1*											2 Groove F = 1¼							
Part Number	Pitch Diameters		OD	Type	Bush	Bush Max. Bore	E	L Thru Bore	M	Wt. Less Bush	Part Number	Type	Bush	Bush Max. Bore	E	L Thru Bore	M	Wt. Less Bush
	A Belt	B Belt																
1 B 34 TB	3.0	3.4	3.75	A-1	1210	1¼	0	1	0	2.2	2 B 34 TB	A-1	1210	1¼	¾	1	0	2.2
1 B 36 TB	3.2	3.6	3.95	A-1	1210	1¼	0	1	0	2.6	2 B 36 TB	A-1	1210	1¼	¾	1	0	2.6
1 B 38 TB	3.4	3.8	4.15	A-1	1610	1½	0	1	0	2.8	2 B 38 TB	A-1	1610	1½	¾	1	0	2.8
1 B 40 TB	3.6	4.0	4.35	A-1	1610	1½	0	1	0	3.0	2 B 40 TB	A-1	1610	1½	¾	1	0	3.0
1 B 42 TB	3.8	4.2	4.55	A-1	1610	1½	0	1	0	3.5	2 B 42 TB	A-1	1610	1½	¾	1	0	4.0
1 B 44 TB	4.0	4.4	4.75	A-1	1610	1½	0	1	0	3.8	2 B 44 TB	A-1	1610	1½	¾	1	0	4.5
1 B 46 TB	4.2	4.6	4.95	A-1	1610	1½	0	1	0	4.0	2 B 46 TB	A-1	1610	1½	¾	1	0	5.0
1 B 48 TB	4.4	4.8	5.15	A-1	1610	1½	0	1	0	4.5	2 B 48 TB	A-1	1610	1½	¾	1	0	5.5
1 B 50 TB	4.6	5.0	5.35	A-1	1610	1½	0	1	0	4.8	2 B 50 TB	A-1	1610	1½	¾	1	0	6.0
1 B 52 TB	4.8	5.2	5.55	A-1	1610	1½	0	1	0	5.0	2 B 52 TB	A-1	1610	1½	¾	1	0	6.5
1 B 54 TB	5.0	5.4	5.75	A-1	1610	1½	0	1	0	5.5	2 B 54 TB	A-1	1610	1½	¾	1	0	7.0
1 B 56 TB	5.2	5.6	5.95	A-1	1610	1½	0	1	0	6.0	2 B 56 TB	A-1	1610	1½	¾	1	0	8.2
1 B 58 TB	5.4	5.8	6.15	A-1	1610	1½	0	1	0	6.3	2 B 58 TB	A-1	1610	1½	¾	1	0	8.6
1 B 60 TB	5.6	6.0	6.35	A-1	1610	1½	0	1	0	6.7	2 B 60 TB	A-1	1610	1½	¾	1	0	8.8
1 B 62 TB	5.8	6.2	6.55	A-1	1610	1½	0	1	0	7.0	2 B 62 TB	A-1	1610	1½	¾	1	0	9.0
1 B 64 TB	6.0	6.4	6.75	A-1	1610	1½	0	1	0	8.0	2 B 64 TB	A-1	1610	1½	¾	1	0	10.0
1 B 66 TB	6.2	6.6	6.95	A-1	1610	1½	0	1	0	8.5	2 B 66 TB	A-1	1610	1½	¾	1	0	10.5
1 B 68 TB	6.4	6.8	7.15	A-1	1610	1½	0	1	0	9.0	2 B 68 TB	A-1	1610	1½	¾	1	0	11.0
1 B 70 TB	7.0	7.4	7.35	B-1	2517	2½	0	1¼	¾	8.5	2 B 74 TB	A-1	2517	2½	0	1¼	0	16.0
1 B 74 TB	7.0	7.4	7.75	B-1	2517	2½	0	1¼	¾	9.4	2 B 86 TB	A-2	2517	2½	0	1¼	0	18.0
1 B 86 TB	8.2	8.6	8.95	B-2	2517	2½	0	1¼	¾	12.0	2 B 94 TB	A-2	2517	2½	0	1¼	0	20.0
1 B 94 TB	9.0	9.4	9.75	B-2	2517	2½	0	1¼	¾	14.0	2 B 110 TB	A-2	2517	2½	0	1¼	0	25.0
1 B 110 TB	10.6	11.0	11.35	B-2	2517	2½	0	1¼	¾	15.6	2 B 124 TB	A-3	2517	2½	0	1¼	0	27.0
1 B 124 TB	12.0	12.4	12.75	C-3	2517	2½	¼	1¼	½	16.2	2 B 136 TB	C-3	2517	2½	0	1¼	0	24.0
1 B 136 TB	13.6	14.0	13.95	C-3	2517	2½	¼	1¼	½	17.2	2 B 154 TB	A-3	2517	2½	0	1¼	0	31.0
1 B 154 TB	15.0	15.4	15.75	C-3	2517	2½	¼	1¼	½	18.0	2 B 160 TB	C-3	2517	2½	0	1¼	0	26.0
1 B 160 TB	16.0	16.4	16.35	C-3	2517	2½	¾	1¼	¾	24.1	2 B 184 TB	A-3	2517	2½	0	1¼	0	33.0
1 B 184 TB	18.0	18.4	18.75	C-3	2517	2½	¾	1¼	¾	31.2	2 B 200 TB	C-3	3020	3	0	2	¼	49.0
											2 B 250 TB	C-3	3020	3	0	2	¼	65.0
											2 B 300 TB	C-3	3020	3	0	2	¼	75.0
											2 B 380 TB	C-3	3020	3	0	2	¼	112.0

Dimensions in inches, weight in pounds. Weights do not include bushings. See page B-8 thru B-10 for additional bushing dimensions.

* F = 1" 1 B 154 TB

F = 1¼" for 1 B 184 TB

A-B Combination Groove Conventional Taper Bushed Stock Sheaves

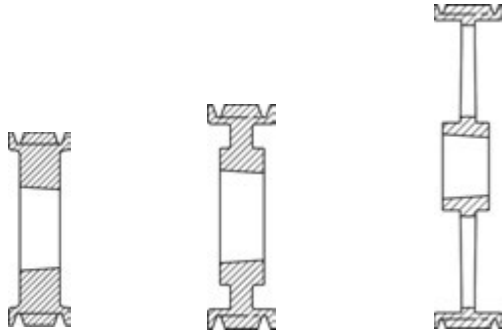

1 = SOLID

2 = WEB

3 = ARM/SPOKE

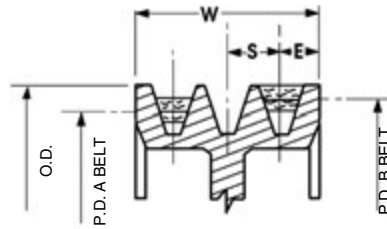

$$W = S(N-1) + 2E$$

$$N = \text{No. of Grooves}$$

Drawing shows position of "A" and "B" belts in groove.

Combination Groove Dimensions

Belt Section	E	S	OD
"AB"	1/2	3/4	P.D. "B" + .35

Taper Bushed Sheaves — A-B

3 Groove F = 2 1/2											4 Groove F = 3 1/4							
Part Number	Diameters		OD	Type	Bush	Bush Max. Bore	E	L Thru Bore	M	Wt. Less Bush	Part Number	Type	Bush	Bush Max. Bore	E	L Thru Bore	M	Wt. Less Bush
	A Belts	B Belts																
3 B 34 TB	3.0	3.4	3.75	A-1	1210	1 1/4	1 1/2	1	0	3.0	4 B 34 TB	A-1	1210	1 1/4	2 1/4	1	0	3.0
3 B 36 TB	3.2	3.6	3.95	A-1	1210	1 1/4	1 1/2	1	0	3.5	4 B 36 TB	A-1	1210	1 1/4	2 1/4	1	0	3.5
3 B 38 TB	3.4	3.8	4.15	A-1	1610	1 1/4	1 1/2	1	0	4.0	4 B 38 TB	A-1	1610	1 1/4	2 1/4	1	0	4.0
3 B 40 TB	3.6	4.0	4.35	A-1	1610	1 1/4	1 1/2	1	0	5.0	4 B 40 TB	A-1	1610	1 1/4	2 1/4	1	0	5.0
3 B 42 TB	3.8	4.2	4.55	A-1	1610	1 1/4	1 1/2	1	0	6.0	4 B 42 TB	A-1	1610	1 1/4	2 1/4	1	0	5.5
3 B 44 TB	4.0	4.4	4.75	A-1	1610	1 1/4	1 1/2	1	0	6.5	4 B 44 TB	A-1	1610	1 1/4	2 1/4	1	0	6.0
3 B 46 TB	4.2	4.6	4.95	A-1	1610	1 1/4	1 1/2	1	0	7.0	4 B 46 TB	A-1	1610	1 1/4	2 1/4	1	0	7.0
3 B 48 TB	4.4	4.8	5.15	A-1	1610	1 1/4	1 1/2	1	0	8.0	4 B 48 TB	A-1	1610	1 1/4	2 1/4	1	0	8.0
3 B 50 TB	4.6	5.0	5.35	A-1	1610	1 1/4	1 1/2	1	0	8.5	4 B 50 TB	A-1	2517	2 1/2	1 1/2	1 1/4	0	8.5
3 B 52 TB	4.8	5.2	5.55	A-1	1610	1 1/4	1 1/2	1	0	9.0	4 B 52 TB	A-1	2517	2 1/2	1 1/2	1 1/4	0	9.0
3 B 54 TB	5.0	5.4	5.75	A-1	2517	2 1/2	1 1/2	1 1/4	0	9.5	4 B 54 TB	A-1	2517	2 1/2	1 1/2	1 1/4	0	9.5
3 B 56 TB	5.2	5.6	5.95	A-1	2517	2 1/2	1 1/2	1 1/4	0	10.0	4 B 56 TB	A-1	2517	2 1/2	1 1/2	1 1/4	0	10.0
3 B 58 TB	5.4	5.8	6.15	A-1	2517	2 1/2	1 1/2	1 1/4	0	10.5	4 B 58 TB	A-1	2517	2 1/2	1 1/2	1 1/4	0	12.0
3 B 60 TB	5.6	6.0	6.35	A-1	2517	2 1/2	1 1/2	1 1/4	0	11.0	4 B 60 TB	A-1	2517	2 1/2	1 1/2	1 1/4	0	12.5
3 B 62 TB	5.8	6.2	6.55	A-1	2517	2 1/2	1 1/2	1 1/4	0	11.5	4 B 62 TB	A-1	2517	2 1/2	1 1/2	1 1/4	0	13.0
3 B 64 TB	6.0	6.4	6.75	A-1	2517	2 1/2	1 1/2	1 1/4	0	12.0	4 B 64 TB	A-1	2517	2 1/2	1 1/2	1 1/4	0	14.0
3 B 66 TB	6.2	6.6	6.95	A-1	2517	2 1/2	1 1/2	1 1/4	0	12.3	4 B 66 TB	A-1	2517	2 1/2	1 1/2	1 1/4	0	15.0
3 B 68 TB	6.4	6.8	7.15	A-1	2517	2 1/2	1 1/2	1 1/4	0	12.8	4 B 68 TB	A-1	2517	2 1/2	1 1/2	1 1/4	0	16.0
3 B 74 TB	7.0	7.4	7.75	A-1	2517	2 1/2	1 1/2	1 1/4	0	16.0	4 B 74 TB	A-1	2517	2 1/2	1 1/2	1 1/4	0	16.0
3 B 80 TB	8.0	8.4	8.35	A-1	2517	2 1/2	0	1 1/4	1 1/2	19.0	4 B 70 TB	A-1	2517	2 1/2	0	1 1/4	1 1/2	20.0
3 B 86 TB	8.2	8.6	8.95	A-2	2517	2 1/2	1 1/2	1 1/4	0	19.0	4 B 80 TB	A-1	2517	2 1/2	0	1 1/4	1 1/2	21.0
3 B 94 TB	9.0	9.4	9.75	A-2	2517	2 1/2	1 1/2	1 1/4	0	21.0	4 B 86 TB	A-2	2517	2 1/2	1 1/2	1 1/4	0	21.0
3 B 110 TB	10.6	11.0	11.35	A-2	2517	2 1/2	1 1/2	1 1/4	0	24.0	4 B 94 TB	A-2	2517	2 1/2	1 1/2	1 1/4	0	23.0
3 B 124 TB	12.0	12.4	12.75	A-3	2517	2 1/2	0	1 1/4	1 1/2	28.0	4 B 110 TB	A-2	2517	2 1/2	1 1/2	1 1/4	0	28.0
3 B 136 TB	13.6	14.0	13.95	A-3	2517	2 1/2	0	1 1/4	1 1/2	25.0	4 B 124 TB	A-3	2517	2 1/2	1 1/2	1 1/4	1 1/2	32.8
3 B 154 TB	15.0	15.4	15.75	A-3	2517	2 1/2	0	1 1/4	1 1/2	30.0	4 B 136 TB	A-3	2517	2 1/2	1 1/2	1 1/4	1 1/2	34.0
3 B 160 TB	16.0	16.4	16.35	A-3	2517	2 1/2	0	1 1/4	1 1/2	32.0	4 B 154 TB	A-3	2517	2 1/2	1 1/2	1 1/4	1 1/2	42.0
3 B 184 TB	18.0	18.4	18.75	A-3	2517	2 1/2	0	1 1/4	1 1/2	44.0	4 B 160 TB	A-3	2517	2 1/2	1 1/2	1 1/4	1 1/2	45.1
3 B 200 TB	19.6	20.0	20.35	A-3	3020	3	0	2 1/2	1 1/2	58.0	4 B 184 TB	A-3	2517	2 1/2	1 1/2	1 1/4	1	53.0
3 B 250 TB	24.6	25.0	25.35	A-3	3020	3	0	2 1/2	1 1/2	74.0	4 B 200 TB	A-3	3020	3	1 1/2	2	1 1/2	63.0
3 B 300 TB	29.6	30.0	30.35	A-3	3020	3	0	2 1/2	1 1/2	84.0	4 B 250 TB	A-3	3030	3	0	3	1 1/4	80.0
3 B 380 TB	37.6	38.0	38.35	B-3	3020	3	0	3	1 1/2	135.0	4 B 300 TB	A-3	3030	3	0	3	1 1/4	100.0
											4 B 380 TB	A-3	3030	3	0	3	1 1/4	142.0

Dimensions in inches, weight in pounds. Weights do not include bushings. See page B-8 thru B-10 for additional bushing dimensions.

Martin

Combination Groove Conventional Taper Bushed Stock Sheaves **A-B**

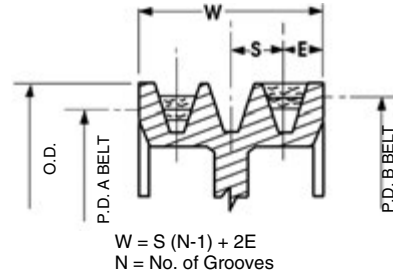
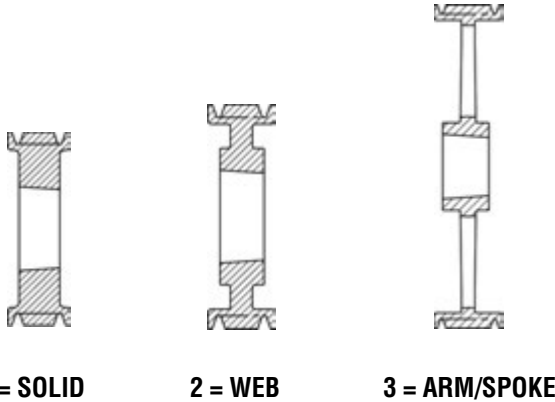

Drawing shows position of "A" and "B" belts in groove.

Combination Groove Dimensions

Belt Section	E	S	OD
"AB"	1/2	3/4	P.D. "B" +.35

Taper Bushed Sheaves — A-B

5 Groove F = 4										6 Groove F = 4 3/4								
Part Number	Diameters		OD	Type	Bush	Bush Max. Bore	E	L Thru Bore	M	Wt. Less Bush	Part Number	Type	Bush	Bush Max. Bore	E	L Thru Bore	M	Wt. Less Bush
	A Belts	B Belts																
5 B 34 TB	3.0	3.4	3.75	A-1	1210	1 1/4	2 1/2	1 1/2	0	5.0								
5 B 36 TB	3.2	3.6	3.95	A-1	1210	1 1/4	2 1/2	1 1/2	0	5.5								
5 B 38 TB	3.4	3.8	4.15	A-1	1215	1 1/4	7/8	1 1/2	1 1/4	6.0								
5 B 40 TB	3.6	4.0	4.35	A-1	1215	1 1/4	7/8	1 1/2	1 1/4	6.5								
5 B 42 TB	3.8	4.2	4.55	A-1	1615	1 1/4	2 1/2	1 1/2	0	7.0	6 B 42 TB	A-1	1615	1 1/4	3 1/4	1 1/2	0	8.0
5 B 44 TB	4.0	4.4	4.75	A-1	1615	1 1/4	2 1/2	1 1/2	0	8.0	6 B 44 TB	A-1	1615	1 1/4	3 1/4	1 1/2	0	9.0
5 B 46 TB	4.2	4.6	4.95	A-1	1615	1 1/4	2 1/2	1 1/2	0	9.0	6 B 46 TB	A-1	1615	1 1/4	3 1/4	1 1/2	0	10.0
5 B 48 TB	4.8	5.2	5.15	A-1	1615	1 1/4	7/8	1 1/2	1 1/4	9.4	6 B 48 TB	A-1	1615	1 1/4	1 1/4	1 1/2	2	11.0
5 B 50 TB	4.6	5.0	5.35	A-1	1615	1 1/4	7/8	1 1/2	0	10.5	6 B 50 TB	A-1	1615	1 1/4	1 1/4	1 1/2	2	11.9
5 B 52 TB	4.8	5.2	5.55	A-1	1615	1 1/4	7/8	1 1/2	0	11.3	6 B 52 TB	A-1	1615	1 1/4	1 1/4	1 1/2	2	12.8
5 B 54 TB	5.0	5.4	5.75	A-1	2517	2 1/2	2 1/4	1 1/4	0	11.5	6 B 54 TB	A-1	2517	1 1/4	1 1/4	1 1/2	2	13.7
5 B 56 TB	5.2	5.6	5.95	A-1	2517	2 1/2	2 1/4	1 1/4	0	12.0	6 B 56 TB	A-1	2517	1 1/4	1 1/4	1 1/2	2	14.6
5 B 58 TB	5.8	6.2	6.15	A-1	2517	2 1/2	1 1/8	1 1/4	1 1/8	13.0	6 B 58 TB	A-1	2517	2 1/2	1 1/8	1 1/4	1 1/4	14.0
5 B 60 TB	5.6	6.0	6.35	A-1	2517	2 1/2	2 1/4	1 1/4	0	14.0	6 B 60 TB	A-1	2517	2 1/2	3	1 1/4	0	16.0
5 B 62 TB	6.2	6.6	6.55	A-1	2517	2 1/2	1 1/8	1 1/4	1 1/8	14.0	6 B 62 TB	A-1	2517	2 1/2	1 1/8	1 1/4	1 1/4	16.0
5 B 64 TB	6.0	6.4	6.75	A-1	2517	2 1/2	2 1/4	1 1/4	0	16.0	6 B 64 TB	A-1	2517	2 1/2	3	1 1/4	0	19.5
5 B 66 TB	6.6	7.0	6.95	A-1	2517	2 1/2	1 1/8	1 1/4	1 1/8	16.0	6 B 66 TB	A-1	2517	2 1/2	1 1/8	1 1/4	1 1/4	20.0
5 B 68 TB	6.4	6.8	7.15	A-1	2517	2 1/2	2 1/4	1 1/4	0	18.0	6 B 68 TB	A-1	2517	2 1/2	3	1 1/4	0	21.0
5 B 70 TB	7.0	7.4	7.35	A-1	2517	2 1/2	3/4	1 1/4	1 1/2	18.0	6 B 70 TB	A-1	2517	2 1/2	1 1/2	1 1/4	1 1/4	21.0
5 B 74 TB	7.0	7.4	7.75	A-1	2517	2 1/2	2 1/4	1 1/4	0	22.0	6 B 74 TB	A-1	2517	2 1/2	3	1 1/4	0	25.0
5 B 80 TB	8.0	8.4	8.35	A-1	2517	2 1/2	1/2	1 1/4	1 1/4	23.0	6 B 80 TB	A-1	2517	2 1/2	1 1/2	1 1/4	1 1/2	26.0
5 B 86 TB	8.2	8.6	8.95	A-2	2517	2 1/2	2 1/4	1 1/4	0	24.0	6 B 86 TB	A-2	2517	2 1/2	3	1 1/4	0	27.0
5 B 94 TB	9.0	9.4	9.75	A-2	2517	2 1/2	2 1/4	1 1/4	0	26.0	6 B 94 TB	A-2	2517	2 1/2	3	1 1/4	0	28.0
5 B 110 TB	10.6	11.0	11.35	A-2	2517	2 1/2	2 1/4	1 1/4	0	35.0	6 B 110 TB	A-2	2517	2 1/2	3	1 1/4	0	34.0
5 B 124 TB	12.0	12.4	12.75	A-3	2517	2 1/2	3/4	1 1/4	1 1/2	40.0	6 B 124 TB	A-3	2517	2 1/2	1 1/8	1 1/4	1 1/4	43.0
5 B 136 TB	13.6	14.0	13.95	A-3	2517	2 1/2	1	1 1/4	1 1/4	38.0	6 B 136 TB	A-3	2517	2 1/2	1 1/8	1 1/4	1 1/2	42.0
5 B 154 TB	15.0	15.4	15.75	A-3	2517	2 1/2	3/4	1 1/4	1 1/2	47.0	6 B 154 TB	A-3	2517	2 1/2	1 1/2	1 1/4	1 1/2	52.0
5 B 160 TB	16.0	16.4	16.35	A-3	2517	2 1/2	3/4	1 1/4	1 1/2	67.0	6 B 160 TB	A-3	2517	2 1/2	1 1/2	1 1/4	1 1/2	53.0
5 B 184 TB	18.0	18.4	18.75	A-3	2517	2 1/2	3/4	1 1/4	1 1/2	52.0	6 B 184 TB	A-3	2517	2 1/2	1 1/2	1 1/4	1 1/2	62.0
5 B 200 TB	19.6	20.0	20.35	A-3	3030	3	1/4	3	3/4	75.0	6 B 200 TB	A-3	3030	3	1/2	3	1 1/4	85.0
5 B 250 TB	24.6	25.0	25.35	A-3	3030	3	1/4	3	3/4	81.0	6 B 250 TB	A-3	3030	3	1/2	3	1 1/4	100.0
5 B 300 TB	29.6	30.0	30.35	A-3	3030	3	1/4	3	3/4	109.0	6 B 300 TB	A-3	3030	3	1/2	3	1 1/4	137.0
5 B 380 TB	37.6	38.0	38.35	A-3	3030	3	1/4	3	3/4	158.0	6 B 380 TB	A-3	3030	3	1/2	3	1 1/4	168.0

A-B Combination Groove Conventional Taper Bushed Stock Sheaves

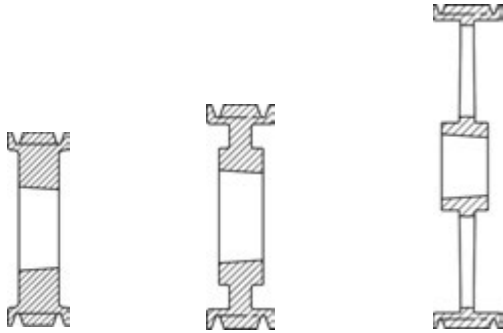

1 = SOLID

2 = WEB

3 = ARM/SPOKE

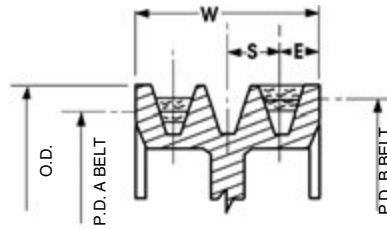

$$W = S(N-1) + 2E$$

$$N = \text{No. of Grooves}$$

Drawing shows position of "A" and "B" belts in groove.

Combination Groove Dimensions

Belt Section	E	S	OD
"AB"	1/2	3/4	P.D. "B" +.35

Taper Bushed Sheaves — A-B

8 Groove										10 Groove								
F = 6 1/4										F = 7 3/4								
Part Number	Diameters		OD	Type	Bush	Bush Max. Bore	E	L Thru Bore	M	Wt. Less Bush	Part Number	Type	Bush	Bush Max. Bore	E	L Thru Bore	M	Wt. Less Bush
	A Belts	B Belts																
8 B 54 TB	5.0	5.4	5.75	A-1	2517	2 1/2	1 1/8	1 1/8	2 1/8	16.0	10 B 54 TB	A-1	2517	2 1/2	3	1 1/8	3	18.0
8 B 56 TB	5.2	5.6	5.95	A-1	2517	2 1/2	1 1/8	1 1/8	2 1/8	17.0	10 B 56 TB	A-1	2517	2 1/2	3	1 1/8	3	20.0
8 B 60 TB	5.6	6.0	6.35	A-1	2517	2 1/2	1 1/8	1 1/8	2 1/8	19.0	10 B 60 TB	A-1	2517	2 1/2	3	1 1/8	3	22.0
8 B 64 TB	6.0	6.4	6.75	A-1	2517	2 1/2	1 1/8	1 1/8	2 1/8	21.0	10 B 64 TB	A-1	2517	2 1/2	3	1 1/8	3	25.5
8 B 68 TB	6.4	6.8	7.15	A-1	2517	2 1/2	1 1/8	1 1/8	2 1/8	25.0	10 B 68 TB	A-1	2517	2 1/2	3	1 1/8	3	28.0
8 B 74 TB	7.0	7.4	7.75	A-1	2517	2 1/2	1 1/8	1 1/8	2 1/8	29.0	10 B 74 TB	A-1	2517	2 1/2	3	1 1/8	3	35.0
8 B 86 TB	8.2	8.6	8.95	A-1	3030	3	1	3	2 1/8	37.0	10 B 86 TB	A-1	3030	3	2	3	2 1/8	43.0
8 B 94 TB	9.0	9.4	9.95	A-2	3030	3	1	3	2 1/8	41.0	10 B 94 TB	A-2	3030	3	2	3	2 1/8	46.0
8 B 110 TB	10.6	11.0	11.35	A-2	3030	3	1	3	2 1/8	51.0	10 B 110 TB	A-2	3030	3	2	3	2 1/8	52.0
8 B 124 TB	12.0	12.4	12.75	A-3	3030	3	1	3	2 1/8	56.0								
8 B 154 TB	15.0	15.4	15.75	A-3	3030	3	1	3	2 1/8	69.0								
8 B 184 TB	18.0	18.4	18.75	A-3	3030	3	1	3	2 1/8	99.0								
8 B 200 TB	19.6	20.0	20.35	A-3	3030	3	1	3	2 1/8	115.0								
8 B 250 TB	24.6	25.0	25.35	A-3	3535	3 1/2	1 1/8	3 1/2	2	145.0								
8 B 300 TB	29.6	30.0	30.35	A-3	3535	3 1/2	1 1/8	3 1/2	2	170.0								
8 B 380 TB	37.6	38.0	38.35	A-3	4040	4	1 1/8	4	1 1/8	260.0								

Dimensions in inches, weight in pounds. Weights do not include bushings. See page B-8 thru B-10 for additional bushing dimensions.

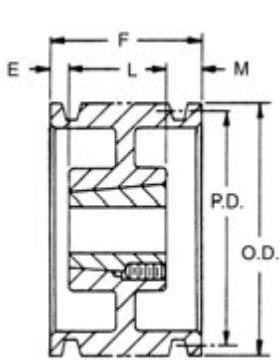

TYPE A

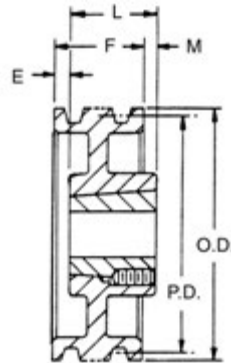

TYPE B

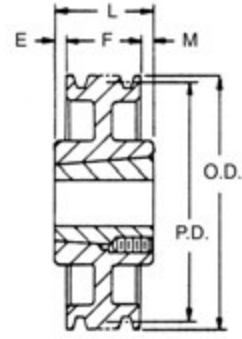

TYPE C

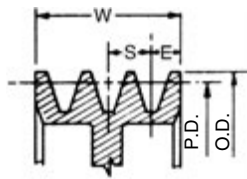

Groove Dimensions

Belt Section	E	S	O.D.
"C"	1/16	1	P.D. + .40

$W = S(N-1) + 2E$
 $N = \text{No. of Grooves}$



1 = SOLID



2 = WEB

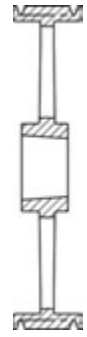

3 = ARM/SPOKE

Taper Bushed Sheaves — C

2 Groove										3 Groove							
F = 2 3/8										F = 3 3/8							
Part Number	PD	OD	Type	Bush	Bush Max. Bore	E	L Thru Bore	M	Wt. Less Bush	Part Number	Type	Bush	Bush Max. Bore	E	L Thru Bore	M	Wt. Less Bush
	C Belt																
2 C 70 TB	7.00	7.40	A-1	2517	2 1/2	3/8	1 1/4	0	15.0	3 C 70 TB	A-1	2517	2 1/2	1/4	1 1/4	1 1/4	18.0
2 C 75 TB	7.50	7.90	A-1	2517	2 1/2	3/8	1 1/4	0	17.0	3 C 75 TB	A-1	2517	2 1/2	1/4	1 1/4	1 1/4	20.0
2 C 80 TB	8.00	8.40	A-1	2517	2 1/2	3/8	1 1/4	0	20.0	3 C 80 TB	A-1	2517	2 1/2	1/4	1 1/4	1 1/4	22.0
2 C 85 TB	8.50	8.90	A-2	2517	2 1/2	3/8	1 1/4	0	22.0	3 C 85 TB	A-2	2517	2 1/2	1/4	1 1/4	1 1/4	23.0
2 C 90 TB	9.00	9.40	A-2	2517	2 1/2	3/8	1 1/4	0	23.0	3 C 90 TB	A-2	2517	2 1/2	1/4	1 1/4	1 1/4	24.0
2 C 95 TB	9.50	9.90	A-2	2517	2 1/2	3/8	1 1/4	0	24.0	3 C 95 TB	A-2	2517	2 1/2	1/4	1 1/4	1 1/4	27.0
2 C 100 TB	10.00	10.40	A-2	2517	2 1/2	3/8	1 1/4	0	25.0	3 C 100 TB	A-2	2517	2 1/2	1/4	1 1/4	1 1/4	29.0
2 C 105 TB	10.50	10.90	A-2	2517	2 1/2	3/8	1 1/4	0	26.0	3 C 105 TB	A-2	2517	2 1/2	1/4	1 1/4	1 1/4	32.0
2 C 110 TB	11.00	11.40	A-2	2517	2 1/2	3/8	1 1/4	0	27.0	3 C 110 TB	A-2	2517	2 1/2	1/4	1 1/4	1 1/4	35.0
2 C 120 TB	12.00	12.40	A-2	2517	2 1/2	3/8	1 1/4	0	33.0	3 C 120 TB	A-2	3020	3	0	2	1 1/4	44.0
2 C 130 TB	13.00	13.40	A-3	2517	2 1/2	3/8	1 1/4	0	35.0	3 C 130 TB	A-3	3020	3	0	2	1 1/4	49.0
2 C 140 TB	14.00	14.40	A-3	2517	2 1/2	3/8	1 1/4	0	36.0	3 C 140 TB	A-3	3020	3	0	2	1 1/4	50.0
2 C 160 TB	16.00	16.40	A-3	2517	2 1/2	3/8	1 1/4	0	42.0	3 C 160 TB	A-3	3020	3	0	2	1 1/4	64.0
2 C 180 TB	18.00	18.40	A-3	3020	3	0	2	3/8	42.0	3 C 180 TB	A-3	3030	3	0	3	3/8	64.0
2 C 200 TB	20.00	20.40	A-3	3020	3	0	2	3/8	45.0	3 C 200 TB	A-3	3030	3	0	3	3/8	78.0
2 C 240 TB	24.00	24.40	A-3	3020	3	0	2	3/8	72.0	3 C 240 TB	A-3	3030	3	0	3	3/8	96.0
2 C 300 TB	30.00	30.40	C-3	3535	3 1/2	1/2	3 1/2	3/8	85.0	3 C 300 TB	B-3	3535	3 1/2	0	3 1/2	1/2	125.0
	36.00	36.40								3 C 360 TB	B-3	3535	3 1/2	0	3 1/2	1/2	175.0

Dimensions in inches, weight in pounds. Weights do not include bushings. See page B-8 thru B-10 for additional bushing dimensions.

C Conventional Stock Taper Bushed Sheaves

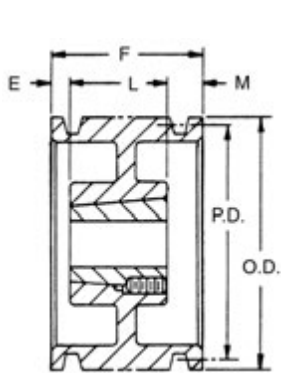

TYPE A

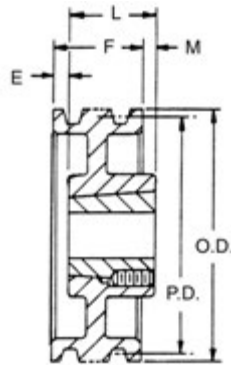

TYPE B

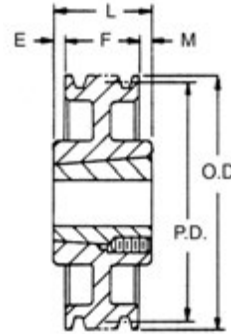

TYPE C



1 = SOLID



2 = WEB



3 = ARM/SPOKE

Taper Bushed Sheaves — C

4 Groove										5 Groove							
F = 4%										F = 5%							
Part Number	PD	OD	Type	Bush	Bush Max. Bore	E	L Thru Bore	M	Wt. Less Bush	Part Number	Type	Bush	Bush Max. Bore	E	L Thru Bore	M	Wt. Less Bush
	C Belt																
4 C 70 TB	7.00	7.40	A-1	2517	2½	½	1¼	2%	20.0	5 C 70 TB	A-1	2517	2½	1½	1¼	2½	23.0
4 C 75 TB	7.50	7.90	A-1	2517	2½	½	1¼	2%	23.0	5 C 75 TB	A-1	2517	2½	1½	1¼	2½	26.0
4 C 80 TB	8.00	8.40	A-1	2517	2½	½	1¼	2%	25.0	5 C 80 TB	A-1	2517	2½	1½	1¼	2½	30.0
4 C 85 TB	8.50	8.90	A-2	2517	2½	½	1¼	2%	26.0	5 C 85 TB	A-1	2517	2½	1½	1¼	2½	34.0
4 C 90 TB	9.00	9.40	A-2	2517	2½	½	1¼	2%	27.0	5 C 90 TB	A-2	2517	2½	1½	1¼	2½	35.0
4 C 95 TB	9.50	9.90	A-2	2517	2½	½	1¼	2%	36.0	5 C 95 TB	A-2	2517	2½	1½	1¼	2½	36.0
4 C 100 TB	10.00	10.40	A-2	2517	2½	½	1¼	2%	39.0	5 C 100 TB	A-2	2517	2½	1½	1¼	2½	39.0
4 C 105 TB	10.50	10.90	A-2	2517	2½	½	1¼	2%	42.0	5 C 105 TB	A-2	2517	2½	1½	1¼	2½	42.0
4 C 110 TB	11.00	11.40	A-2	2517	2½	½	1¼	2%	45.0	5 C 110 TB	A-2	2517	2½	1½	1¼	2½	43.0
4 C 120 TB	12.00	12.40	A-2	3030	3	0	3	1%	47.0	5 C 120 TB	A-2	3030	3	½	3	1%	58.0
4 C 130 TB	13.00	13.40	A-3	3030	3	0	3	1%	51.0	5 C 130 TB	A-3	3030	3	½	3	1%	63.0
4 C 140 TB	14.00	14.40	A-3	3030	3	0	3	1%	54.0	5 C 140 TB	A-3	3030	3	½	3	1%	65.0
4 C 160 TB	16.00	16.40	A-3	3030	3	0	3	1%	71.0	5 C 160 TB	A-3	3030	3	½	3	1%	70.0
4 C 180 TB	18.00	18.40	A-3	3030	3	0	3	1%	81.0	5 C 180 TB	A-3	3030	3	½	3	1%	83.0
4 C 200 TB	20.00	20.40	A-3	3030	3	0	3	1%	84.0	5 C 200 TB	A-3	3535	3½	0	3½	1%	110.0
4 C 240 TB	24.00	24.40	A-3	3030	3	0	3	1%	116.0	5 C 240 TB	A-3	3535	3½	0	3½	1%	138.0
4 C 300 TB	30.00	30.40	A-3	3535	3½	0	3½	½	164.0	5 C 300 TB	A-3	3535	3½	0	3½	1%	176.0
4 C 360 TB	36.00	36.40	A-3	3535	3½	0	3½	¾	192.0	5 C 360 TB	A-3	4040	4	¼	4	1%	244.0
4 C 440 TB	44.00	44.40	A-3	4040	4	0	4	¾	282.0	5 C 440 TB	A-3	4040	4	¼	4	1%	288.0

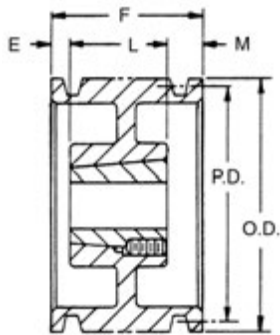

TYPE A

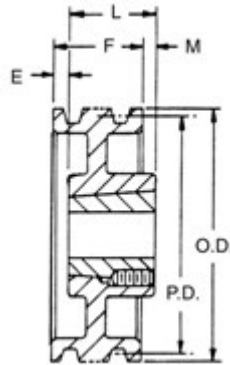

TYPE B

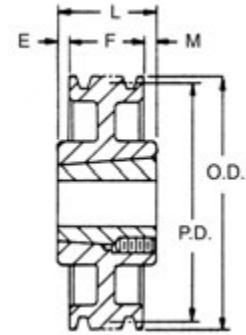

TYPE C



1 = SOLID



2 = WEB



3 = ARM/SPOKE

Taper Bushed Sheaves — C

6 Groove F = 6%										8 Groove F = 8%								
Part Number	PD	OD	Type	Bush	Bush Max. Bore	E	L Thru Bore	M	Wt. Less Bush	Part Number	Type	Bush	Bush Max. Bore	E	L Thru Bore	M	Wt. Less Bush	
	C Belt																	Part Number
6 C 70 TB	7.00	7.40	A-1	3030	3	1	3	2%	30.0	8 C 80 TB	A-1	3030	3	2	3	3%	45.0	
6 C 75 TB	7.50	7.90	A-1	3030	3	1	3	2%	31.0		8 C 85 TB	A-1	3030	3	2	3	3%	47.0
6 C 80 TB	8.00	8.40	A-1	3030	3	1	3	2%	35.0		8 C 90 TB	A-1	3535	3½	1½	3½	3%	64.0
6 C 85 TB	8.50	8.90	A-1	3030	3	1	3	2%	40.0		8 C 95 TB	A-1	3535	3½	1½	3½	3%	67.0
6 C 90 TB	9.00	9.40	A-1	3030	3	1	3	2%	47.0		8 C 100 TB	A-1	3535	3½	1½	3½	3%	70.0
6 C 95 TB	9.50	9.90	A-1	3030	3	1	3	2%	53.0	8 C 105 TB	A-1	3535	3½	1½	3½	3%	84.0	
6 C 100 TB	10.00	10.40	A-1	3030	3	1	3	2%	57.0	8 C 110 TB	A-1	3535	3½	1½	3½	3%	87.0	
6 C 105 TB	10.50	10.90	A-2	3030	3	1	3	2%	58.0	8 C 120 TB	A-2	3535	3½	1½	3½	3%	90.0	
6 C 110 TB	11.00	11.40	A-2	3030	3	1	3	2%	66.0	8 C 130 TB	A-2	3535	3½	1½	3½	3%	97.0	
6 C 120 TB	12.00	12.40	A-2	3030	3	1	3	2%	70.0	8 C 140 TB	A-2	3535	3½	1½	3½	3%	105.0	
6 C 130 TB	13.00	13.40	A-3	3030	3	1	3	2%	75.0	8 C 160 TB	A-3	3535	3½	1½	3½	3%	115.0	
6 C 140 TB	14.00	14.40	A-3	3535	3½	½	3½	2%	80.0	8 C 180 TB	A-3	4040	4	1½	4	2%	137.0	
6 C 160 TB	16.00	16.40	A-3	3535	3½	½	3½	2%	87.0	8 C 200 TB	A-3	4040	4	1½	4	2%	180.0	
6 C 180 TB	18.00	18.40	A-3	3535	3½	½	3½	2%	102.0	8 C 240 TB	A-3	4040	4	1½	4	2%	205.0	
6 C 200 TB	20.00	20.40	A-3	3535	3½	½	3½	2%	126.0	8 C 300 TB	A-3	4040	4	1½	4	2%	263.0	
6 C 240 TB	24.00	24.40	A-3	3535	3½	½	3½	2%	150.0	8 C 360 TB	A-3	4545	4½	1½	4½	2%	343.0	
6 C 300 TB	30.00	30.40	A-3	4040	4	1	4	1%	226.0	8 C 440 TB	A-3	4545	4½	1½	4½	2%	432.0	
6 C 360 TB	36.00	36.40	A-3	4040	4	1	4	1%	270.0									
6 C 440 TB	44.00	44.40	A-3	4040	4	1	4	1%	320.0									

C Conventional Stock Taper Bushed Sheaves

Martin

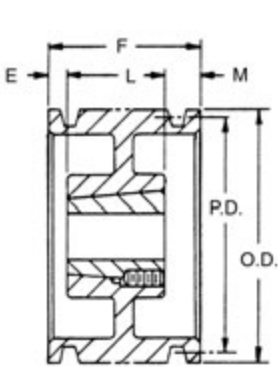

TYPE A

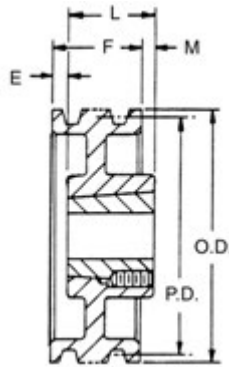

TYPE B

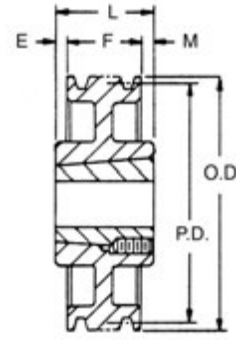

TYPE C



1 = SOLID



2 = WEB



3 = ARM/SPOKE

Taper Bushed Sheaves — C

10 Groove										12 Groove							
F = 10%										F = 12%							
Part Number	PD	OD	Type	Bush	Bush Max. Bore	E	L Thru Bore	M	Wt. Less Bush	Part Number	Type	Bush	Bush Max. Bore	E	L Thru Bore	M	Wt. Less Bush
	C Belt																
10 C 90 TB	9.00	9.40	A-1	4545	4½	1½	4½	4%	57.0	12 C 90 TB	A-1	4040	4	3½	4	4%	65.0
10 C 95 TB	9.50	9.90	A-1	4545	4½	1½	4½	4%	66.0	12 C 95 TB	A-1	4040	4	3½	4	4%	75.0
10 C 100 TB	10.00	10.40	A-1	4545	4½	1½	4½	4%	77.0	12 C 100 TB	A-1	4040	4	3½	4	4%	85.0
10 C 105 TB	10.50	10.90	A-1	4545	4½	1½	4½	4%	87.0	12 C 105 TB	A-1	4040	4	3½	4	4%	95.0
10 C 110 TB	11.00	11.40	A-1	4545	4½	1½	4½	4%	98.0	12 C 110 TB	A-1	4040	4	3½	4	4%	104.0
10 C 120 TB	12.00	12.40	A-1	4545	4½	1½	4½	4%	121.0	12 C 120 TB	A-1	4040	4	3½	4	4%	126.0
10 C 130 TB	13.00	13.40	A-1	4545	4½	2	4½	3%	146.0	12 C 130 TB	A-1	4545	4½	3	4½	4%	156.0
10 C 140 TB	14.00	14.40	A-2	4545	4½	2	4½	3%	170.1	12 C 140 TB	A-1	4545	4½	3	4½	4%	184.0
10 C 160 TB	16.00	16.40	A-2	4545	4½	2	4½	3%	173.4								
10 C 180 TB	18.00	18.40	A-2	4545	4½	2	4½	3%	180.1								
10 C 200 TB	20.00	20.40	A-3	4545	4½	2	4½	3%	201.0								
10 C 240 TB	24.00	24.40	A-3	4545	4½	2	4½	3%	243.0								
10 C 300 TB	30.00	30.40	A-3	4545	4½	2	4½	3%	320.0								
10 C 360 TB	36.00	36.40	A-3	4545	4½	2	4½	3%	464.0								
10 C 440 TB	44.00	44.40	A-3	4545	4½	2	4½	3%	508.0								

Dimensions in inches, weight in pounds. Weights do not include bushings. See page B-8 thru B-10 for additional bushing dimensions.